

HYDRA BIG

self-cleaning filter

TECHNICAL CATALOGUE

OPEN TO CLEAN



CERTIFICATIONS:



Self-cleaning filters are tested and certified under the most stringent procedures worldwide, in compliance with the sanitary certifications DM25 -Italy-, ACS -France-, EAC/Ghostreghistrizia -Russia- and WaterMark (Australia).

HYDRA BIG

Self-cleaning filters with back-wash

The self-cleaning filter HYDRA BIG is the union of strength, reliability and elegance of a purely Italian style with the highest performance and excellent quality of materials. All this to ensure maximum protection of your system, even at very high flow rates. Cleaning operations are quick and easy: simply open the valve at the bottom of the filter to create a reversal of the water flow. In this way all the impurities are dragged and expelled from the filter. The efficiency of this process is guaranteed by the discharge system designed to block the reflux of the expelled water.



POINT OF ENTRY



COLD WATER



MAX WORKING PRESSURE
8,3 bar (120 psi)
MIN WORKING PRESSURE
1,8 bar (26 psi)



MAX WORKING TEMPERATURE
45°C (113°F)
MIN WORKING TEMPERATURE
4°C (39.2°F)

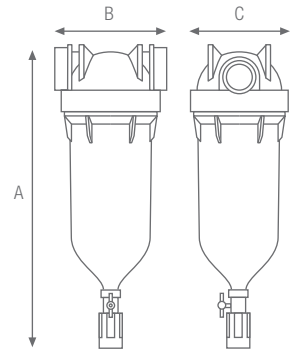

HYDRA BIG

HYDRA BIG M

VERSIONS

TECHNICAL SPECIFICATIONS

Selected raw materials, suitable for drinking water.

Head: reinforced polypropylene.

Bowl: PET.

O-ring: silicone.

Breather-valve: body polypropylene, o-ring EPDM.

In/out brass threads (1" models):

CW617N brass (BSPP) - CW511L "Lead Free" (NPT).

Discharge ball-valve:

CW617N brass nickel plated (BSPP versions);

CW511L "Lead Free" brass nickel plated (NPT versions).

Drain funnel: reinforced polypropylene.

Gauges (M models): radial type, pressure range 0-12 bar, 0-170 psi.

CW617N brass (BSPP versions); CW511L "Lead Free" (NPT versions)

FLOW RATE vs PRESSURE DROP

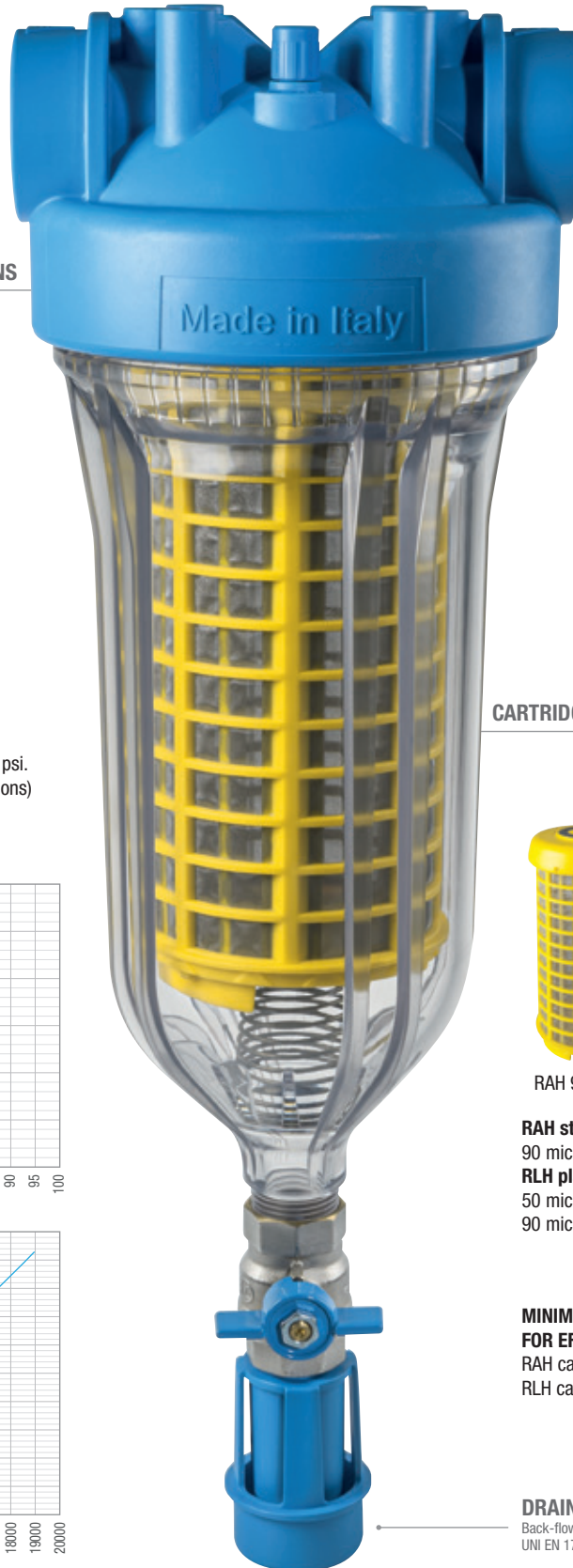
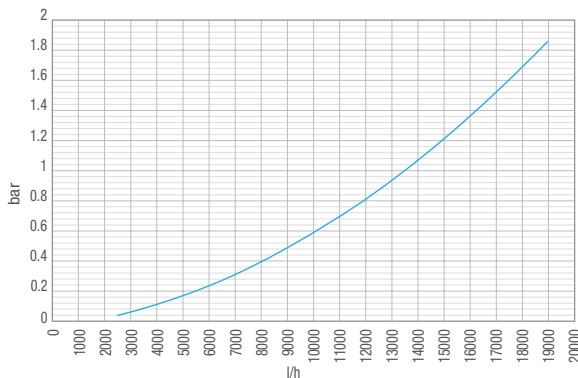
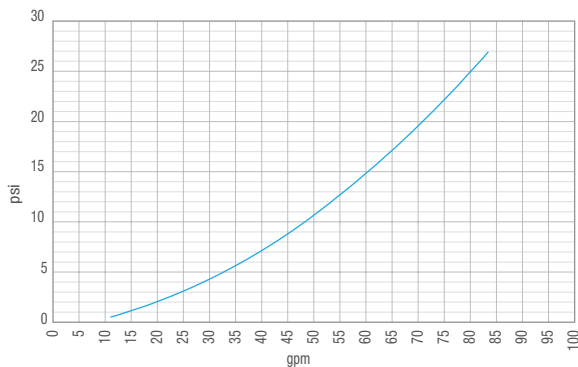

THREADS TYPE

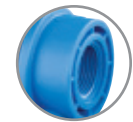

IN PLASTIC BSPP



NPT IN PLASTIC NPT



OT BRASS BSPP



NTP OT BRASS NPT Lead Free

CARTRIDGES

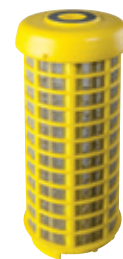

RAH 90 mcr

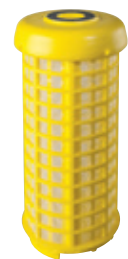

RLH 50/90 mcr

RAH stainless steel net cartridge

90 micron - CODE RA5001020

RLH plastic net cartridge

50 micron - CODE RA5001005

90 micron - CODE RA5001010

MINIMUM FLOW RATE FOR EFFECTIVE BACKWASHING:

RAH cartridges = 2000 l/h

RLH cartridges = 2400 l/h

DRAIN FUNNEL

Back-flow preventing device
UNI EN 1717-11/2002

HYDRA BIG DUO | TRIO

Multi-stage self-cleaning filters with back-wash

HYDRA BIG DUO doubles its effectiveness thanks to the second stage after the self-cleaning pre-filter, which allows us to choose the most suitable cartridge from a wide range of BIG cartridges at our disposal. Finally, with HYDRA BIG TRIO we close the circle of the HYDRA BIG range: two stages after the self-cleaning prefilter to be dedicated to the improvement of our water.



POINT OF ENTRY



COLD WATER



MAX WORKING PRESSURE
8,3 bar (120 psi)
MIN WORKING PRESSURE
1,8 bar (26 psi)



MAX WORKING TEMPERATURE
45°C (113°F)
MIN WORKING TEMPERATURE
4°C (39.2°F)

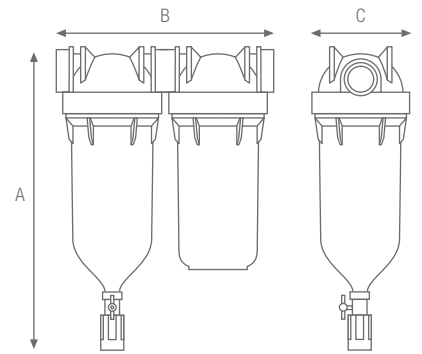

VERSIONS



HYDRA BIG DUO



HYDRA BIG M DUO
with 3 gauges



HYDRA BIG TRIO



HYDRA BIG M TRIO
with 4 gauges

DRAIN FUNNEL

Back-flow preventing device
UNI EN 1717-11/2002

For TECHNICAL SPECIFICATIONS - THREADS TYPE - CARTRIDGES SPECIFICATIONS see HYDRA BIG page



HYDRA BIG single-stage self-cleaning filters

HOUSINGS WITH PLASTIC BSPP THREADS

PART NUMBER	MODEL	NOMINAL FILTRATION mcr	IN/OUT	MAX FLOW RATE l/h	MAX FLOW RATE gpm	DIMENSIONS mm		
						A	B	C
RA6310000	HYDRA BIG 1" RLH 50 mcr IN	50	1"	6000	26	500	190	185
RA6310003	HYDRA BIG 1"1/2 RLH 50mcr IN	50	1"1/2	15000	66	500	190	185
RA6310010	HYDRA BIG 1" RLH 90 mcr IN	90	1"	6000	26	500	190	185
RA6310013	HYDRA BIG 1"1/2 RLH 90mcr IN	90	1"1/2	15000	66	500	190	185
RA6310030	HYDRA BIG 1" RAH 90 mcr IN	90	1"	6000	26	500	190	185
RA6310033	HYDRA BIG 1"1/2 RAH 90 mcr IN	90	1"1/2	15000	66	500	190	185

HOUSINGS WITH PLASTIC NPT THREADS

PART NUMBER	MODEL	NOMINAL FILTRATION mcr	IN/OUT	MAX FLOW RATE l/h	MAX FLOW RATE gpm	DIMENSIONS mm		
						A	B	C
RA6314000	HYDRA BIG 1" RLH 50 mcr NPT IN	50	1"	6000	26	500	190	185
RA6314003	HYDRA BIG 1"1/2 RLH 50 mcr NPT IN	50	1"1/2	15000	66	500	190	185
RA6314010	HYDRA BIG 1" RLH 90 mcr NPT IN	90	1"	6000	26	500	190	185
RA6314013	HYDRA BIG 1"1/2 RLH 90 mcr NPT IN	90	1"1/2	15000	66	500	190	185
RA6314030	HYDRA BIG 1" RAH 90 mcr NPT IN	90	1"	6000	26	500	190	185
RA6314033	HYDRA BIG 1"1/2 RAH 90 mcr NPT IN	90	1"1/2	15000	66	500	190	185

HOUSINGS WITH BRASS BSPP THREADS

PART NUMBER	MODEL	NOMINAL FILTRATION mcr	IN/OUT	MAX FLOW RATE l/h	MAX FLOW RATE gpm	DIMENSIONS mm		
						A	B	C
RA6312000	HYDRA BIG 1" RLH 50 mcr OT	50	1"	6000	26	500	190	185
RA6312010	HYDRA BIG 1" RLH 90 mcr OT	90	1"	6000	26	500	190	185
RA6312030	HYDRA BIG 1" RAH 90 mcr OT	90	1"	6000	26	500	190	185

HOUSINGS WITH BRASS NPT THREADS

PART NUMBER	MODEL	NOMINAL FILTRATION mcr	IN/OUT	MAX FLOW RATE l/h	MAX FLOW RATE gpm	DIMENSIONS mm		
						A	B	C
RA6316000	HYDRA BIG 1" RLH 50 mcr NPT OT	50	1"	6000	26	500	190	185
RA6316010	HYDRA BIG 1" RLH 90 mcr NPT OT	90	1"	6000	26	500	190	185
RA6316030	HYDRA BIG 1" RAH 90 mcr NPT OT	90	1"	6000	26	500	190	185



HYDRA BIG M single-stage self-cleaning filters with 2 gauges

HOUSINGS WITH PLASTIC BSPP THREADS

PART NUMBER	MODEL	NOMINAL FILTRATION mcr	IN/OUT	MAX FLOW RATE l/h	MAX FLOW RATE gpm	DIMENSIONS mm		
						A	B	C
RA6310300	HYDRA BIG M 1" RLH 50 mcr IN	50	1"	6000	26	570	190	185
RA6310303	HYDRA BIG M 1"1/2 RLH 50 mcr IN	50	1"1/2	15000	66	570	190	185
RA6310310	HYDRA BIG M 1" RLH 90 mcr IN	90	1"	6000	26	570	190	185
RA6310313	HYDRA BIG M 1"1/2 RLH 90 mcr IN	90	1"1/2	15000	66	570	190	185
RA6310330	HYDRA BIG M 1" RAH 90 mcr IN	90	1"	6000	26	570	190	185
RA6310333	HYDRA BIG M 1"1/2 RAH 90 mcr IN	90	1"1/2	15000	66	570	190	185

HOUSINGS WITH PLASTIC NPT THREADS

PART NUMBER	MODEL	NOMINAL FILTRATION mcr	IN/OUT	MAX FLOW RATE l/h	MAX FLOW RATE gpm	DIMENSIONS mm		
						A	B	C
RA6314300	HYDRA BIG M 1" RLH 50 mcr NPT IN	50	1"	6000	26	570	190	185
RA6314303	HYDRA BIG M 1"1/2 RLH 50 mcr NPT IN	50	1"1/2	15000	66	570	190	185
RA6314310	HYDRA BIG M 1" RLH 90 mcr NPT IN	90	1"	6000	26	570	190	185
RA6314313	HYDRA BIG M 1"1/2 RLH 90 mcr NPT IN	90	1"1/2	15000	66	570	190	185
RA6314330	HYDRA BIG M 1" RAH 90 mcr NPT IN	90	1"	6000	26	570	190	185
RA6314333	HYDRA BIG M 1"1/2 RAH 90 mcr NPT IN	90	1"1/2	15000	66	570	190	185

HOUSINGS WITH BRASS BSPP THREADS

PART NUMBER	MODEL	NOMINAL FILTRATION mcr	IN/OUT	MAX FLOW RATE l/h	MAX FLOW RATE gpm	DIMENSIONS mm		
						A	B	C
RA6312300	HYDRA BIG M 1" RLH 50 mcr OT	50	1"	6000	26	570	190	185
RA6312310	HYDRA BIG M 1" RLH 90 mcr OT	90	1"	6000	26	570	190	185
RA6312330	HYDRA BIG M 1" RAH 90 mcr OT	90	1"	6000	26	570	190	185

HOUSINGS WITH BRASS NPT THREADS

PART NUMBER	MODEL	NOMINAL FILTRATION mcr	IN/OUT	MAX FLOW RATE l/h	MAX FLOW RATE gpm	DIMENSIONS mm		
						A	B	C
RA6316300	HYDRA BIG M 1" RLH 50 mcr NPT OT	50	1"	6000	26	570	190	185
RA6316310	HYDRA BIG M 1" RLH 90 mcr NPT OT	90	1"	6000	26	570	190	185
RA6316330	HYDRA BIG M 1" RAH 90 mcr NPT OT	90	1"	6000	26	570	190	185



HYDRA BIG DUO double-stage self-cleaning filters

HOUSINGS WITH PLASTIC BSPP THREADS

PART NUMBER	MODEL	NOMINAL FILTRATION mcr	IN/OUT	DIMENSIONS mm		
				A	B	C
RA6320000	HYDRA BIG DUO 1" RLH 50 mcr IN	50	1"	515	390	185
RA6320003	HYDRA BIG DUO 1"1/2 RLH 50 mcr IN	50	1"1/2	515	390	185
RA6320010	HYDRA BIG DUO 1" RLH 90 mcr IN	90	1"	515	390	185
RA6320013	HYDRA BIG DUO 1"1/2 RLH 90 mcr IN	90	1"1/2	515	390	185
RA6320030	HYDRA BIG DUO 1" RAH 90 mcr IN	90	1"	515	390	185
RA6320033	HYDRA BIG DUO 1"1/2 RAH 90 mcr IN	90	1"1/2	515	390	185

HOUSINGS WITH PLASTIC NPT THREADS

PART NUMBER	MODEL	NOMINAL FILTRATION mcr	IN/OUT	DIMENSIONS mm		
				A	B	C
RA6324000	HYDRA BIG DUO 1" RLH 50 mcr NPT IN	50	1"	515	390	185
RA6324003	HYDRA BIG DUO 1"1/2 RLH 50 mcr NPT IN	50	1"1/2	515	390	185
RA6324010	HYDRA BIG DUO 1" RLH 90 mcr NPT IN	90	1"	515	390	185
RA6324013	HYDRA BIG DUO 1"1/2 RLH 90 mcr NPT IN	90	1"1/2	515	390	185
RA6324030	HYDRA BIG DUO 1" RAH 90 mcr NPT IN	90	1"	515	390	185
RA6324033	HYDRA BIG DUO 1"1/2 RAH 90 mcr NPT IN	90	1"1/2	515	390	185

HOUSINGS WITH BRASS BSPP THREADS

PART NUMBER	MODEL	NOMINAL FILTRATION mcr	IN/OUT	DIMENSIONS mm		
				A	B	C
RA6322000	HYDRA BIG DUO 1" RLH 50 mcr OT	50	1"	515	390	185
RA6322010	HYDRA BIG DUO 1" RLH 90 mcr OT	90	1"	515	390	185
RA6322030	HYDRA BIG DUO 1" RAH 90 mcr OT	90	1"	515	390	185

HOUSINGS WITH BRASS NPT THREADS

PART NUMBER	MODEL	NOMINAL FILTRATION mcr	IN/OUT	DIMENSIONS mm		
				A	B	C
RA6326000	HYDRA BIG DUO 1" RLH 50 mcr NPT OT	50	1"	515	390	185
RA6326010	HYDRA BIG DUO 1" RLH 90 mcr NPT OT	90	1"	515	390	185
RA6326030	HYDRA BIG DUO 1" RAH 90 mcr NPT OT	90	1"	515	390	185



HYDRA BIG M DUO double-stage self-cleaning filters with 3 gauges

HOUSINGS WITH PLASTIC BSPP THREADS

PART NUMBER	MODEL	NOMINAL FILTRATION mcr	IN/OUT	DIMENSIONS mm		
				A	B	C
RA6320300	HYDRA BIG M DUO 1" RLH 50 mcr IN	50	1"	585	390	185
RA6320303	HYDRA BIG M DUO 1"1/2 RLH 50mcr IN	50	1"1/2	585	390	185
RA6320310	HYDRA BIG M DUO 1" RLH 90 mcr IN	90	1"	585	390	185
RA6320313	HYDRA BIG M DUO 1"1/2 RLH 90mcr IN	90	1"1/2	585	390	185
RA6320330	HYDRA BIG M DUO 1" RAH 90 mcr IN	90	1"	585	390	185
RA6320333	HYDRA BIG M DUO 1"1/2 RAH 90 mcr IN	90	1"1/2	585	390	185

HOUSINGS WITH PLASTIC NPT THREADS

PART NUMBER	MODEL	NOMINAL FILTRATION mcr	IN/OUT	DIMENSIONS mm		
				A	B	C
RA6324300	HYDRA BIG M DUO 1" RLH 50 mcr NPT IN	50	1"	585	390	185
RA6324303	HYDRA BIG M DUO 1"1/2 RLH 50mcr NPT IN	50	1"1/2	585	390	185
RA6324310	HYDRA BIG M DUO 1" RLH 90 mcr NPT IN	90	1"	585	390	185
RA6324313	HYDRA BIG M DUO 1"1/2 RLH 90 mcr NPT IN	90	1"1/2	585	390	185
RA6324330	HYDRA BIG M DUO 1" RAH 90 mcr NPT IN	90	1"	585	390	185
RA6324333	HYDRA BIG M DUO 1"1/2 RAH 90 mcr NPT IN	90	1"1/2	585	390	185

HOUSINGS WITH BRASS BSPP THREADS

PART NUMBER	MODEL	NOMINAL FILTRATION mcr	IN/OUT	DIMENSIONS mm		
				A	B	C
RA6322300	HYDRA BIG M DUO 1" RLH 50 mcr OT	50	1"	585	390	185
RA6322310	HYDRA BIG M DUO 1" RLH 90 mcr OT	90	1"	585	390	185
RA6322330	HYDRA BIG M DUO 1" RAH 90 mcr OT	90	1"	585	390	185

HOUSINGS WITH BRASS NPT THREADS

PART NUMBER	MODEL	NOMINAL FILTRATION mcr	IN/OUT	DIMENSIONS mm		
				A	B	C
RA6326300	HYDRA BIG M DUO 1" RLH 50 mcr NPT OT	50	1"	585	390	185
RA6326310	HYDRA BIG M DUO 1" RLH 90 mcr NPT OT	90	1"	585	390	185
RA6326330	HYDRA BIG M DUO 1" RAH 90 mcr NPT OT	90	1"	585	390	185



HYDRA BIG TRIO triple-stage self-cleaning filters

HOUSINGS WITH PLASTIC BSPP THREADS

PART NUMBER	MODEL	NOMINAL FILTRATION mcr	IN/OUT	DIMENSIONS mm		
				A	B	C
RA6330000	HYDRA BIG TRIO 1" RLH 50 mcr IN	50	1"	515	590	185
RA6330003	HYDRA BIG TRIO 1" 1/2 RLH 50mcr IN	50	1"1/2	515	590	185
RA6330010	HYDRA BIG TRIO 1" RLH 90 mcr IN	90	1"	515	590	185
RA6330013	HYDRA BIG TRIO 1" 1/2 RLH 90 mcr IN	90	1"1/2	515	590	185
RA6330030	HYDRA BIG TRIO 1" RAH 90 mcr IN	90	1"	515	590	185
RA6330033	HYDRA BIG TRIO 1" 1/2 RAH 90 mcr IN	90	1"1/2	515	590	185

HOUSINGS WITH PLASTIC NPT THREADS

PART NUMBER	MODEL	NOMINAL FILTRATION mcr	IN/OUT	DIMENSIONS mm		
				A	B	C
RA6334000	HYDRA BIG TRIO 1" RLH 50 mcr NPT IN	50	1"	515	590	185
RA6334003	HYDRA BIG TRIO 1" 1/2 RLH 50 mcr NPT IN	50	1"1/2	515	590	185
RA6334010	HYDRA BIG TRIO 1" RLH 90 mcr NPT IN	90	1"	515	590	185
RA6334013	HYDRA BIG TRIO 1" 1/2 RLH 90 mcr NPT IN	90	1"1/2	515	590	185
RA6334030	HYDRA BIG TRIO 1" RAH 90 mcr NPT IN	90	1"	515	590	185
RA6334033	HYDRA BIG TRIO 1" 1/2 RAH 90 mcr NPT IN	90	1"1/2	515	590	185

HOUSINGS WITH BRASS BSPP THREADS

PART NUMBER	MODEL	NOMINAL FILTRATION mcr	IN/OUT	DIMENSIONS mm		
				A	B	C
RA6332000	HYDRA BIG TRIO 1" RLH 50 mcr OT	50	1"	515	590	185
RA6332010	HYDRA BIG TRIO 1" RLH 90 mcr OT	90	1"	515	590	185
RA6332030	HYDRA BIG TRIO 1" RAH 90 mcr OT	90	1"	515	590	185

HOUSINGS WITH BRASS NPT THREADS

PART NUMBER	MODEL	NOMINAL FILTRATION mcr	IN/OUT	DIMENSIONS mm		
				A	B	C
RA6336000	HYDRA BIG TRIO 1" RLH 50 mcr NPT OT	50	1"	515	590	185
RA6336010	HYDRA BIG TRIO 1" RLH 90 mcr NPT OT	90	1"	515	590	185
RA6336030	HYDRA BIG TRIO 1" RAH 90 mcr NPT OT	90	1"	515	590	185



HYDRA BIG M TRIO triple-stage self-cleaning filters with 4 gauges

HOUSINGS WITH PLASTIC BSPP THREADS

PART NUMBER	MODEL	NOMINAL FILTRATION mcr	IN/OUT	DIMENSIONS mm		
				A	B	C
RA6330300	HYDRA BIG M TRIO 1" RLH 50 mcr IN	50	1"	585	590	185
RA6330303	HYDRA BIG M TRIO 1" 1/2 RLH 50 mcr IN	50	1"1/2	585	590	185
RA6330310	HYDRA BIG M TRIO 1" RLH 90 mcr IN	90	1"	585	590	185
RA6330313	HYDRA BIG M TRIO 1" 1/2 RLH 90 mcr IN	90	1"1/2	585	590	185
RA6330330	HYDRA BIG M TRIO 1" RAH 90 mcr IN	90	1"	585	590	185
RA6330333	HYDRA BIG M TRIO 1" 1/2 RAH 90 mcr IN	90	1"1/2	585	590	185

HOUSINGS WITH PLASTIC NPT THREADS

PART NUMBER	MODEL	NOMINAL FILTRATION mcr	IN/OUT	DIMENSIONS mm		
				A	B	C
RA6334300	HYDRA BIG M TRIO 1" RLH 50 mcr NPT IN	50	1"	585	590	185
RA6334303	HYDRA BIG M TRIO 1" 1/2 RLH 50 mcr NPT IN	50	1"1/2	585	590	185
RA6334310	HYDRA BIG M TRIO 1" RLH 90 mcr NPT IN	90	1"	585	590	185
RA6334313	HYDRA BIG M TRIO 1" 1/2 RLH 90 mcr NPT IN	90	1"1/2	585	590	185
RA6334330	HYDRA BIG M TRIO 1" RAH 90 mcr NPT IN	90	1"	585	590	185
RA6334333	HYDRA BIG M TRIO 1" 1/2 RAH 90 mcr NPT IN	90	1"1/2	585	590	185

HOUSINGS WITH BRASS BSPP THREADS

PART NUMBER	MODEL	NOMINAL FILTRATION mcr	IN/OUT	DIMENSIONS mm		
				A	B	C
RA6332300	HYDRA BIG M TRIO 1" RLH 50 mcr OT	50	1"	585	590	185
RA6332310	HYDRA BIG M TRIO 1" RLH 90 mcr OT	90	1"	585	590	185
RA6332330	HYDRA BIG M TRIO 1" RAH 90 mcr OT	90	1"	585	590	185

HOUSINGS WITH BRASS NPT THREADS

PART NUMBER	MODEL	NOMINAL FILTRATION mcr	IN/OUT	DIMENSIONS mm		
				A	B	C
RA6336300	HYDRA BIG M TRIO 1" RLH 50 mcr NPT OT	50	1"	585	590	185
RA6336310	HYDRA BIG M TRIO 1" RLH 90 mcr NPT OT	90	1"	585	590	185
RA6336330	HYDRA BIG M TRIO 1" RAH 90 mcr NPT OT	90	1"	585	590	185



HYDRA **BIG**
self-cleaning filter



www.atlasfiltri.com